

Nobel Prize Physiology 2016 ("For His Discoveries of Mechanisms For Autophagy") Awarded on Molecular Basis (Anatomy Or B-Bit) of Autophagy. Divine Mechanics (CCP, Code PCPS and CP), the Physiology is absent. It Is Divine MONB That Underpins Formation of Autophagosome. Hence the Work Is Incomplete.

Dr V M Das

Das Nursing Home, Fatehgarh , India University of God

Abstract: Basic mechanisms of autophagy is still obscure. The reason being, one is not equipped with basic knowledge of structure of the matter, origin of the universe and atomic genetics as taught by a new science called participatory science. If one breaks the matter, one would get its last and smallest particles called basic building blocks (B.B.Bs.) of which all fermions and bosons are composed. From these fermions and bosons all the matter of the universe is formed including human cell. These basic units are divine in the sense that they talk with each other by phenomenon called atomic transcription and translation. These are fundamental particles and atomic transcription and translation are fundamental working of the nature. These B.B.Bs. have power to transmutate to form bigger units of the universe like particles, atoms, molecules, cells, individuals, earth, solar system, galaxies etc. So, all effects of the universe are triggered by atomic transcription and translation or thought expressions. The normal cell structures and functions of normal cell are triggered by normal thought expressions of normal structural configuration and normal functions. That is why we observe normal structural configuration of cell and normal functions both originated by genes and membrane (electrical activity of the cell) . In autophagy , structural formation of autophagosome is triggered by basic building block (Yang B.B.B.) of genes involved in nucleus . Nucleus transcribes different mRNAs of structural proteins that are required in formation of autophagosome . These proteins are formed in cytoplasm and they unite to form autophagosome . At each step , it is CCP that triggers the mechanism and there is feed back to higher center before next thought is expressed to complete the formation of autophagosome . There are many thoughts (structural and functional) that are involved in the phenomenon of autophagy . But to understand the concept few thoughts are depicted in diagrams. The phenomenon of autophagy is triggered by outer stimuli (outer stress or inner stress). It is conditioned thought stimulation of CCP. In dead person physiology is absent. Physiology is higher thought expressions of B.B.B. in living body or living cell.

Keywords: Basic Building Blocks, Atomic Genetics, Atomic Transcription and Translation, Tachyons, Mind and Mass, Quantum consciousness

I. Introduction

1.1 Summary [1]

This year's Nobel Laureate discovered and elucidated mechanisms underlying *autophagy*, a fundamental process for degrading and recycling cellular components.

The word *autophagy* originates from the Greek words *auto-*, meaning "self", and *phagein*, meaning "to eat". Thus, *autophagy* denotes "self eating". This concept emerged during the 1960's, when researchers first observed that the cell could destroy its own contents by enclosing it in membranes, forming sack-like vesicles that were transported to a recycling compartment, called the *lysosome*, for degradation. Difficulties in studying the phenomenon meant that little was known until, in a series of brilliant experiments in the early 1990's, Yoshinori Ohsumi used baker's yeast to identify genes essential for autophagy. He then went on to elucidate the underlying mechanisms for autophagy in yeast and showed that similar sophisticated machinery is used in our cells. Ohsumi's discoveries led to a new paradigm in our understanding of how the cell recycles its content. His discoveries opened the path to understanding the fundamental importance of autophagy in many physiological processes, such as in the adaptation to starvation or response to infection. Mutations in autophagy genes can cause disease, and the autophagic process is involved in several conditions including cancer and neurological disease.

Degradation – a central function in all living cells

In the mid 1950's scientists observed a new specialized cellular compartment, called an *organelle*, containing enzymes that digest proteins, carbohydrates and lipids. This specialized compartment is referred to as a "*lysosome*" and functions as a workstation for degradation of cellular constituents. The Belgian scientist Christian de Duve was awarded the Nobel Prize in Physiology or Medicine in 1974 for the discovery of the lysosome. New observations during the 1960's showed that large amounts of cellular content, and even whole organelles, could sometimes be found inside lysosomes. The cell therefore appeared to have a strategy for delivering large cargo to the lysosome. Further biochemical and microscopic analysis revealed a new type of vesicle transporting cellular cargo to the lysosome for degradation (Figure below). Christian de Duve, the scientist behind the discovery of the lysosome, coined the term autophagy, "self-eating", to describe this process. The new vesicles were named *autophagosomes*.

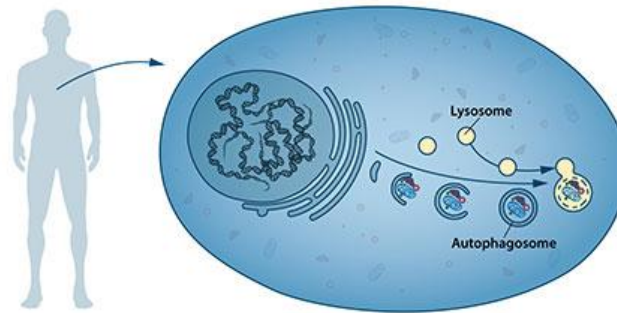

Figure our cells have different specialized compartments. Lysosomes constitute one such compartment and contain enzymes for digestion of cellular contents. A new type of vesicle called autophagosome was observed within the cell. As the autophagosome forms, it engulfs cellular contents, such as damaged proteins and organelles. Finally, it fuses with the lysosome, where the contents are degraded into smaller constituents. This process provides the cell with nutrients and building blocks for renewal.

During the 1970's and 1980's researchers focused on elucidating another system used to degrade proteins, namely the "proteasome". Within this research field Aaron Ciechanover, Avram Hershko and Irwin Rose were awarded the 2004 Nobel Prize in Chemistry for "the discovery of ubiquitin-mediated protein degradation". The proteasome efficiently degrades proteins one-by-one, but this mechanism did not explain how the cell got rid of larger protein complexes and worn-out organelles. Could the process of autophagy be the answer and, if so, what were the mechanisms?

A groundbreaking experiment

Yoshinori Ohsumi had been active in various research areas, but upon starting his own lab in 1988, he focused his efforts on protein degradation in the *vacuole*, an organelle that corresponds to the lysosome in human cells. Yeast cells are relatively easy to study and consequently they are often used as a model for human cells. They are particularly useful for the identification of genes that are important in complex cellular pathways. But Ohsumi faced a major challenge; yeast cells are small and their inner structures are not easily distinguished under the microscope and thus he was uncertain whether autophagy even existed in this organism. Ohsumi reasoned that if he could disrupt the degradation process in the vacuole while the process of autophagy was active, then autophagosomes should accumulate within the vacuole and become visible under the microscope. He therefore cultured mutated yeast lacking vacuolar degradation enzymes and simultaneously stimulated autophagy by starving the cells. The results were striking! Within hours, the vacuoles were filled with small vesicles that had not been degraded (Figure below). The vesicles were autophagosomes and Ohsumi's experiment proved that autophagy exists in yeast cells. But even more importantly, he now had a method to identify and characterize key genes involved this process. This was a major break-through and Ohsumi published the results in 1992.

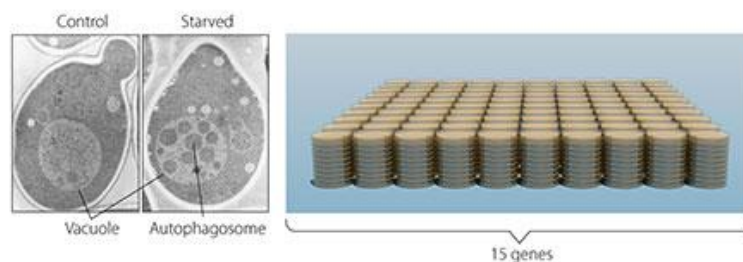

Figure: In yeast (left panel) a large compartment called the *vacuole* corresponds to the lysosome in mammalian cells. Ohsumi generated yeast lacking vacuolar degradation enzymes. When these yeast cells were starved, autophagosomes rapidly accumulated in the vacuole (middle panel). His experiment demonstrated that autophagy exists in yeast. As a next step, Ohsumi studied thousands of yeast mutants (right panel) and identified 15 genes that are essential for autophagy.

Autophagy genes are discovered

Ohsumi now took advantage of his engineered yeast strains in which autophagosomes accumulated during starvation. This accumulation should not occur if genes important for autophagy were inactivated. Ohsumi exposed the yeast cells to a chemical that randomly introduced mutations in many genes, and then he induced autophagy. His strategy worked! Within a year of his discovery of autophagy in yeast, Ohsumi had identified the first genes essential for autophagy. In his subsequent series of elegant studies, the proteins encoded by these genes were functionally characterized. The results showed that autophagy is controlled by a cascade of proteins and protein complexes, each regulating a distinct stage of autophagosome initiation and formation (Figure below).

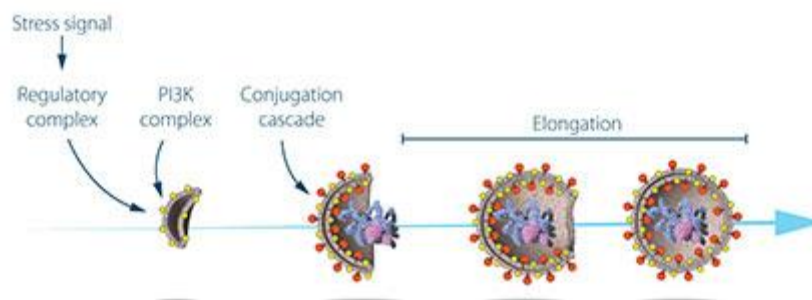

Figure Ohsumi studied the function of the proteins encoded by key autophagy genes. He delineated how stress signals initiate autophagy and the mechanism by which proteins and protein complexes promote distinct stages of autophagosome formation.

Autophagy – an essential mechanism in our cells

After the identification of the machinery for autophagy in yeast, a key question remained. Was there a corresponding mechanism to control this process in other organisms? Soon it became clear that virtually identical mechanisms operate in our own cells. The research tools required to investigate the importance of autophagy in humans were now available.

Thanks to Ohsumi and others following in his footsteps, we now know that autophagy controls important physiological functions where cellular components need to be degraded and recycled. Autophagy can rapidly provide fuel for energy and building blocks for renewal of cellular components, and is therefore essential for the cellular response to starvation and other types of stress. After infection, autophagy can eliminate invading intracellular bacteria and viruses. Autophagy contributes to embryo development and cell differentiation. Cells also use autophagy to eliminate damaged proteins and organelles, a quality control mechanism that is critical for counteracting the negative consequences of aging.

Disrupted autophagy has been linked to Parkinson's disease, type 2 diabetes and other disorders that appear in the elderly. Mutations in autophagy genes can cause genetic disease. Disturbances in the autophagic machinery have also been linked to cancer. Intense research is now ongoing to develop drugs that can target autophagy in various diseases. Autophagy has been known for over 50 years but its fundamental importance in physiology and medicine was only recognized after Yoshinori Ohsumi's paradigm-shifting research in the 1990's. For his discoveries, he is awarded this year's Nobel Prize in physiology or medicine.

What is New Physics or Physics of Mind?

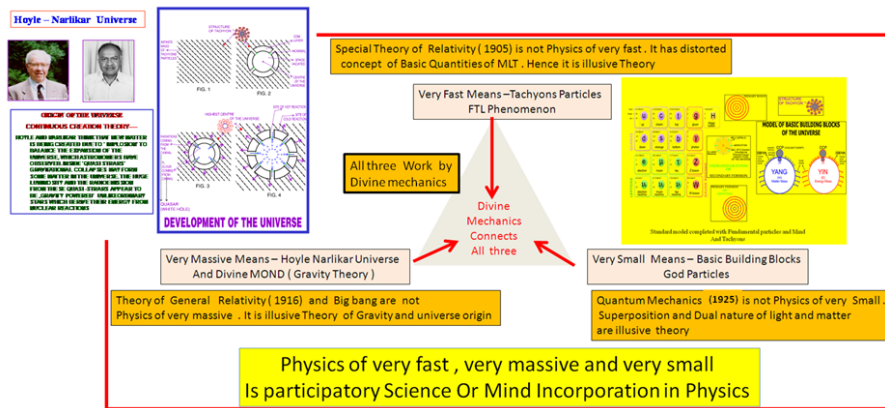

Physics of Mind

Quantum Consciousness – According to Physicists and Biologist



The nature of consciousness remains deeply mysterious and profoundly important, with existential, medical and spiritual implication. We know what it is like to *be* conscious – to have awareness, a conscious ‘mind’, but who, or what, are ‘we’ who know such things? How is the subjective nature of phenomenal experience – our ‘inner life’ - to be explained in scientific terms? What consciousness actually *is*, and how it comes about remain unknown. The general assumption in modern science and philosophy - the ‘standard model’ - is that consciousness emerges from complex computation among brain neurons, computation whose currency is seen as neuronal firings (‘spikes’) and synaptic transmissions, equated with binary ‘bits’ in digital computing. Consciousness is presumed to ‘emerge’ from complex neuronal computation, and to have arisen during biological evolution as an adaptation of living systems, extrinsic to the makeup of the universe. On the other hand, spiritual and contemplative traditions, and some scientists and philosophers consider consciousness to be intrinsic, ‘woven into the fabric of the universe’. In these views, conscious precursors and Platonic forms preceded biology, existing all along in the fine scale structure of reality.

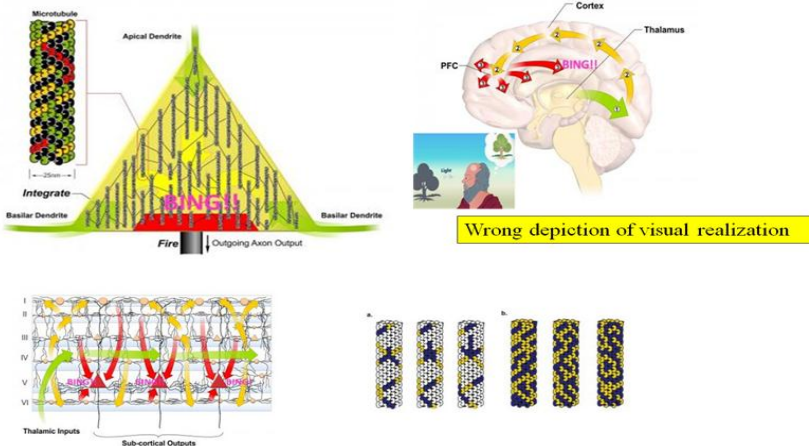

My research involves a theory of consciousness which can bridge these two approaches, a theory developed over the past 20 years with eminent British physicist Sir Roger Penrose. Called ‘orchestrated objective reduction’ (‘Orch OR’), it suggests consciousness arises from quantum vibrations in protein polymers called microtubules inside the brain’s neurons, vibrations which interfere, ‘collapse’ and resonate across scale, control neuronal firings, generate consciousness, and connect ultimately to ‘deeper order’ ripples in spacetime geometry. Consciousness is more like music than computation.

Colleagues Travis Craddock and Jack Tuszynski and I also study how anesthetics act in microtubules to erase consciousness, and with Jay Sanguinetti, John JB Allen and Sterling Cooley, we are studying how transcranial ultrasound (TUS) can be used noninvasively to resonate brain microtubules and treat mental, cognitive and neurological disorders.

Many thanks to my assistant Abi Behar-Montefiore and Ed Xia for maintaining this website.

STUART R. HAMEROFF, MD

Director, Center for Consciousness Studies
 Professor Emeritus
 Department of Anesthesiology, College of Medicine,
 University of Arizona and Department of Psychology
 Banner – University Medical Center Tucson

Quantum Consciousness Theorist & Researcher
 hameroff@u.arizona.edu

1.2 Mind and Mass Realities [2]

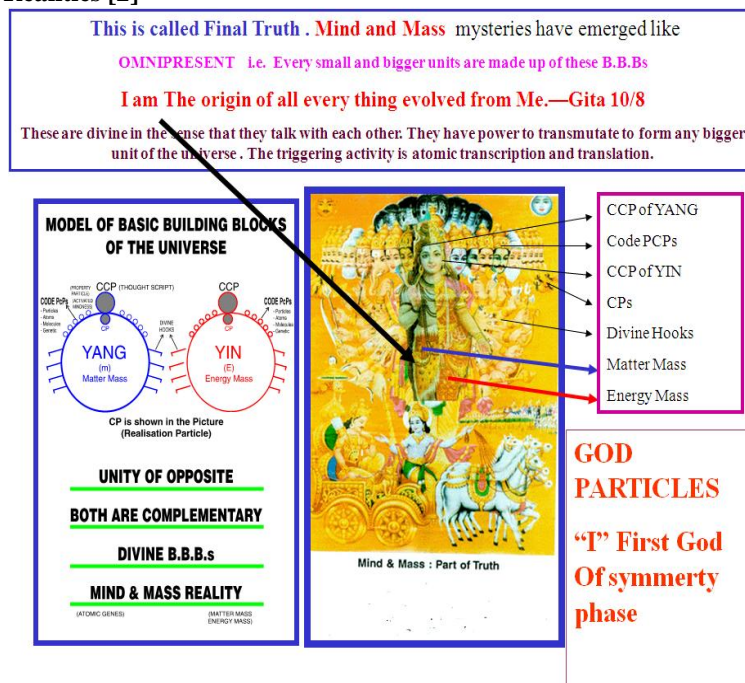

Fig. 1 Divine Mechanics Unit – CCP, CP and information s – Code PcPs with B-Bit – Mass

Atomic genetics is the branch of science where we investigate about fundamental interactions of the universe i.e. atomic transcription and translations . New words have been coined to understand hidden science of mind part of reality. Mind reality has been recognized as different faces by “T” about 5000 years back to Arjuna in Mahabharata.as shown in Fig 1. It is just like to understand any language through Alphabets. These are (different faces) Alphabets of mind reality. One Mind reality has one face identity and the second mind reality has second face identity and so on. The facial expression represents phenomenon of intelligence and different faces represent different types of properties carrying property. The open eyes means property is activated while close eye means property is inactivated. In spite of carrying properties consciousness they also know how to conduct not only origin of universe but also how to create two different universe i.e. next creation could be different from this creation . In all, it is automatic system of the universe . The mind realities which are of good properties have devtas face identity (first five faces on both side) and those mind realities which

are of bad properties have demons face identity (last four faces on both side) . These are named as code PCPs or messenger atomic genes . The central face is CCP or Thought script where all thoughts of the universe are banked . It is bank of data of all information s of the universe It is face identity of Anti mind particles as data of all information's of the universe are stored as anti mind particles . It is the Time mind ness (biological clock) that keeps on expressing different thoughts from this thought script (CCP) . There are four more faces (black bodies) shown on extreme left and right floating in fire are CPs (translating Atomic genes) . That translates the messages and realizes it and reacts accordingly.[2]

1.3. Messages From Biological world to understand B.B.B world as shown in Fig 2 [2]

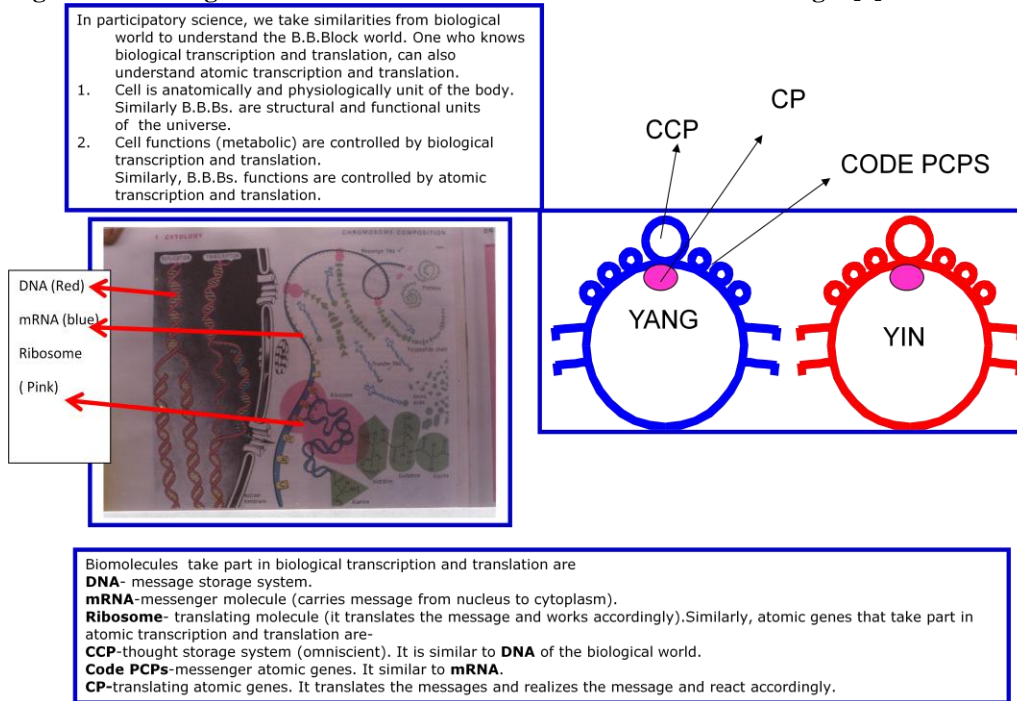
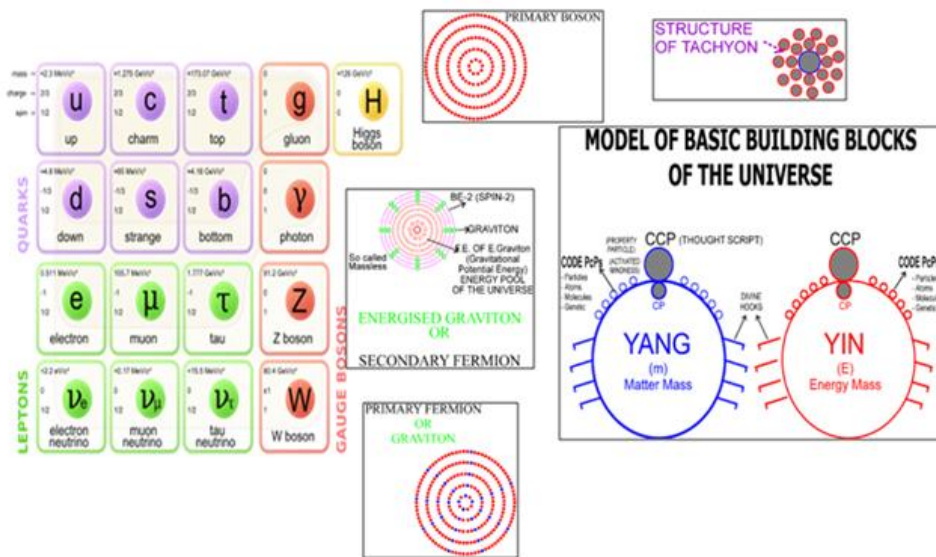

Fig. 2 Parallel teaching by participatory science

The standard model not only modified rather it has been completed [3] with introduction of energized gravitons , primary fermions, primary bosons , Basic Building Blocks , Mind and Tachyons as shown in Fig 3



Standard model completed with Fundamental particles and Mind And Tachyons

Fig. 3 standard Model chart [3]

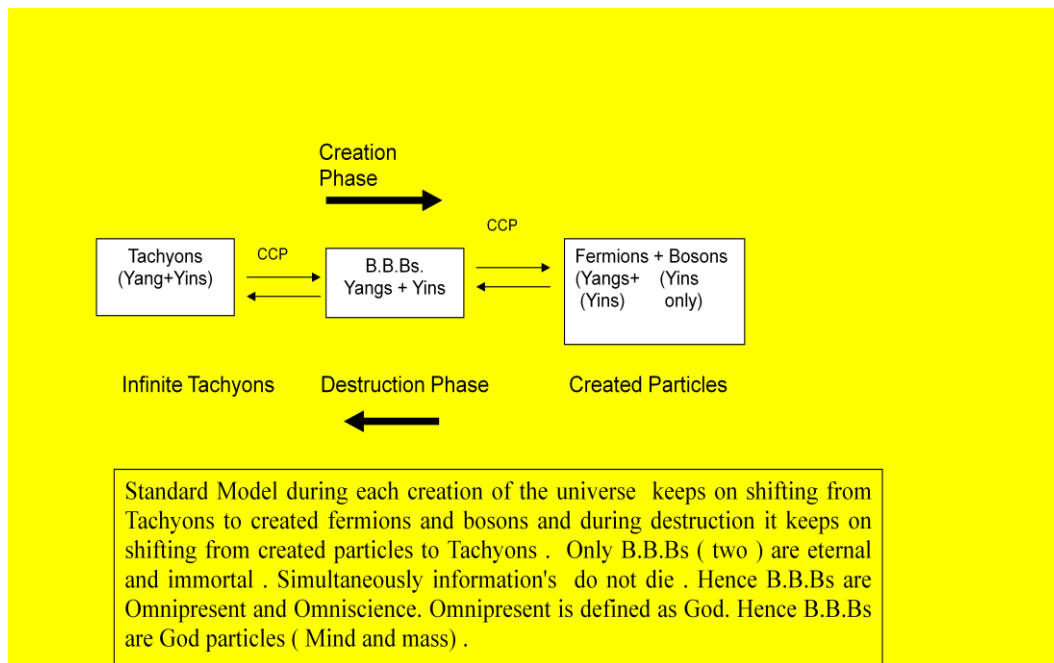

Fig .3.1 one creation and destruction cycle [4]

Participatory science has coined [5] some new words and there are some words which already exist in physics. Both these words are defined here and the definitions are according to participatory science. It has no relation with the definitions given in modern physics.

1. Mass - The part which gives shape to the smallest mass unit i.e. basics building blocks (B. B. Bs.) is called mass.
2. Matter:-Mixture of fermions and bosons or only bosons which are made up of mass (B.B.Bs) and that is why we realize their shape is called matter.
3. Inertial mass:-Mass (smallest mass units i.e. B. B. Bs) having inertial properties (classical inertia) either absolute rest or uniform motion in straight line is called inertial mass. Or Number of B. B. Bs. Per unit space present in bigger units is called inertial mass. Or Total matter contained by the bigger units or total number of fermions and bosons contained by the bigger units is called inertial mass. Therefore it never changes from place to place.
4. Gravitational mass:- The mass (interacting surfaces) which takes part in gravity (divine energized gravitons theory) interaction (which is due to mind) is called gravitational mass. When gravity interaction increases (number of divine energized gravitons increases) the interacting mass (interacting surface) also increases or when interacting mass (interacting surfaces) increases, gravity interaction (number of divine energized gravitons) also increases. Therefore gravitational mass (interacting mass or surfaces) changes from place to place. It is the fed mind that decides gravity interaction. We shall discuss it in gravity chapter and in atomic genetics.
5. Pure m (matter) mass:-matter mass (smallest mass unit or B.B.B) which have got inertial property of absolute rest.
6. Energy mass:-Energy mass (smallest energy mass unit B.B.B) which have got inertial property of uniform motion in straight line and which also gives shape to the bigger energy mass (Higgs Bosons etc) units.
7. m (impure matter) of $E=mc^2$:-Matter particles (fermions) which have got spin property are called impure matter particles.

1.4 Prayer message formation in brain.

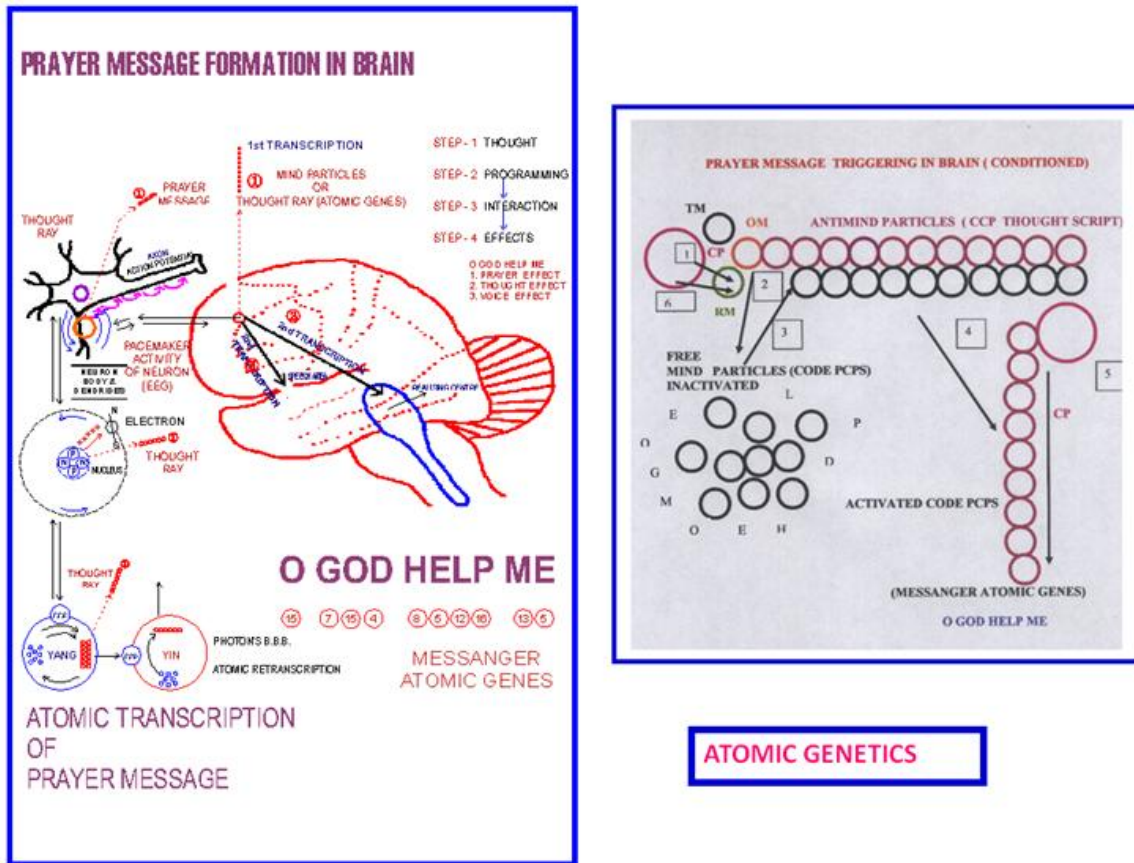

Fig 4 Divine Mechanics - Prayer message formation in brain

In atomic transcription and translation of prayer [5], following steps take place on Yang B.B.B – B-Bit as shown in Figure 4.

1. CP removes RM (repressor mindness-green) from OM (operating mindness -orange) thus induction of atomic transcription triggers.
2. OM triggers activation of free mind particles (black -inactivated code PCPs) of that thought script (magenta) of “o god help me ”.
3. Free mind particles (black -inactivated code PCPs) get attached to anti mind particles script (magenta one) to form messenger thought script of “o god help me ”.
4. Messenger atomic genes (black) get activated by anti mind particles thought script and further they get detached from anti mind particles thought script to form activated messenger atomic genes (activated code PCPs) (magenta) of “ o god help me ”
5. CP carries phenomenon of splicing by translating the messenger activated atomic genes (activated code PCPS) and finally there is activated message of “o god help me” is formed .
6. CP represses atomic transcription by adding RM (green) to OM (orange) . Thus atomic transcription gets halt.

Having formed the message it comes out in three forms .

In atomic genetic engineering (prayer) we use our basic power i.e. power of B.B.Bs. Our B.B.B. (higher center) talks with highest center of the universe by sending the message by first transcription. Till today nobody knows how does the brain generate thoughts. I am going to tell you that mystery too. In the frontal lobe the neurons are responsible for thought generation. In the neuron there is electrical activity called pacemaker activity which is occurring between dendrites and the body of the neuron. The membrane of the cell is made up of atoms and atom is made up of B.B.Bs. At the level of B.B.B. say thought of 'O GOD HELP ME' is expressed. As a result programmed messages of O GOD HELP ME (code PCPs) are formed. Out of three programmed messages, one is carried by atomic genes to highest center of the universe. It is called **THOUGHT RAY (Quantum entanglement)** which is made up of pure atomic genes and then the message goes through phenomenon called first transcription. They come out from brain directly. The other two messages are carried by photons from nucleus of atom to electrons. Here they are modulated on electrical activity of the cell called

pacemaker activity. Further they are modulated on actions potentials going towards **REALIZING CENTER** situated in brain stem (RAS) and from RAS to speech area situated in the frontal area. Target B.B.Bs. of the realizing center finally realizes thought effect of O GOD HELP ME. While from speech area message goes to motor cortex again via RAS and from there to vocal cords and finally it comes out as a speech effect of O GOD HELP ME. In layman's terminology formation of the thought ray means PRAYER as shown in Fig 4

Where Does Prayer Message go ?

Prayer message goes as shown in Figure 5 to highest center of the universe via first transcription where it is realized and it is accepted, the highest center sends two messages to B.B.Bs working as higher center in cancer cell. These messages are message of inhibition of abnormal thought expression and message of activation of normal thought expression. Having received the messages, higher center stops expressing the abnormal thoughts and it starts expressing the normal thoughts. As a result, there are no more abnormal programmed messages and in place of that normal programmed messages are there. Now the messages have shifted from abnormal (5 and 6) to normal (2 and 3). This shifting of thought expression is called **ATOMIC GENETIC ENGINEERING** as shown in Figure 4.1

The changed messages reach to target B.B.Bs. through same route. Having received the changed messages, target B.B.Bs. stop expressing the previous programming and they start expressing the normal programming. As a result the cancer cells transmutate into normal cells. **Or diseased cell gets cured [6]** as shown in Fig 4.1

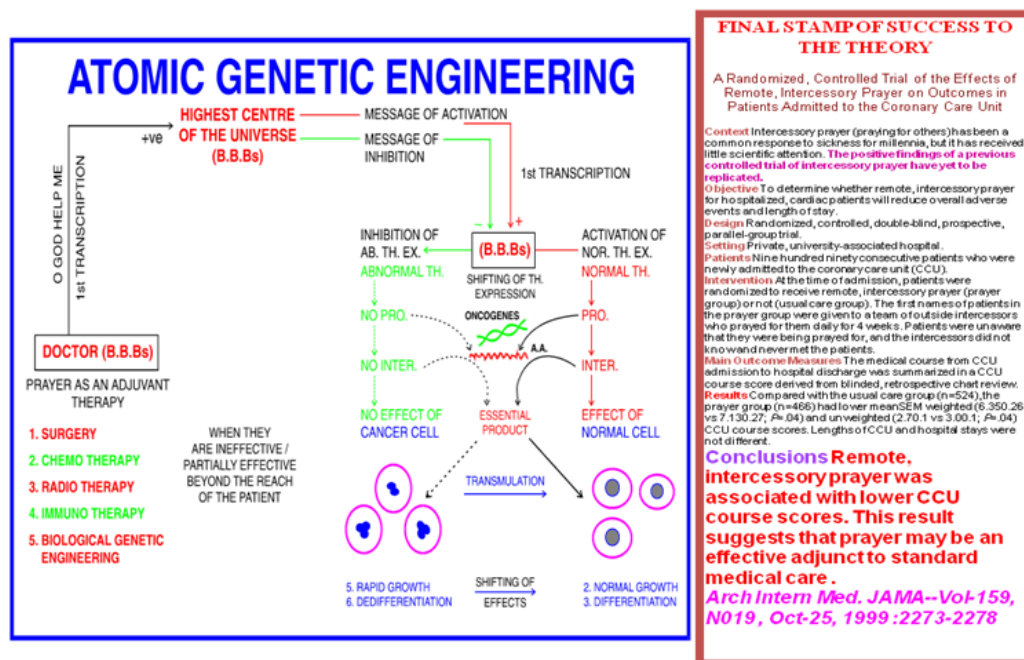

Fig. 4.1 A.G.E and Final stamp of success to New Theory[6]

1.5 Message system of the Universe

Before the origin of the universe [2] nature had only one type of message systems which is called FIRST TRANSCRIPTION. Messages (Code PcPs) used to go from one B.B.B. to another B.B.B. by atomic transcription. Messages were carried by atomic genes (Code PcPs) with very very high velocity. It is the fundamental message system.

After the origin of the universe, nature created atoms. It also created one more message system called SECOND TRANSCRIPTION. Here the message (code PcPs) are carried by photons from one atom to another atom with velocity of light. Thus atoms, molecules, cells, and even individuals talk with one another

After the formation of the cell, nature created one more system called THIRD TRANSCRIPTION. Here there is a message storage system formed by DNA. There are messenger molecules called mRNA that carry message from DNA script to cytoplasm where the message (code PCPs) is read or translated by ribosome and they work accordingly. Thus the messages reach to enzymes and hormones and finally messages reach to target units. Having received the messages, target units work accordingly. Finally life effects (metabolic) are observed.

These three types of message systems are working in the nature. These message system are being used by the nature according to nature's need. as shown in Fig 5

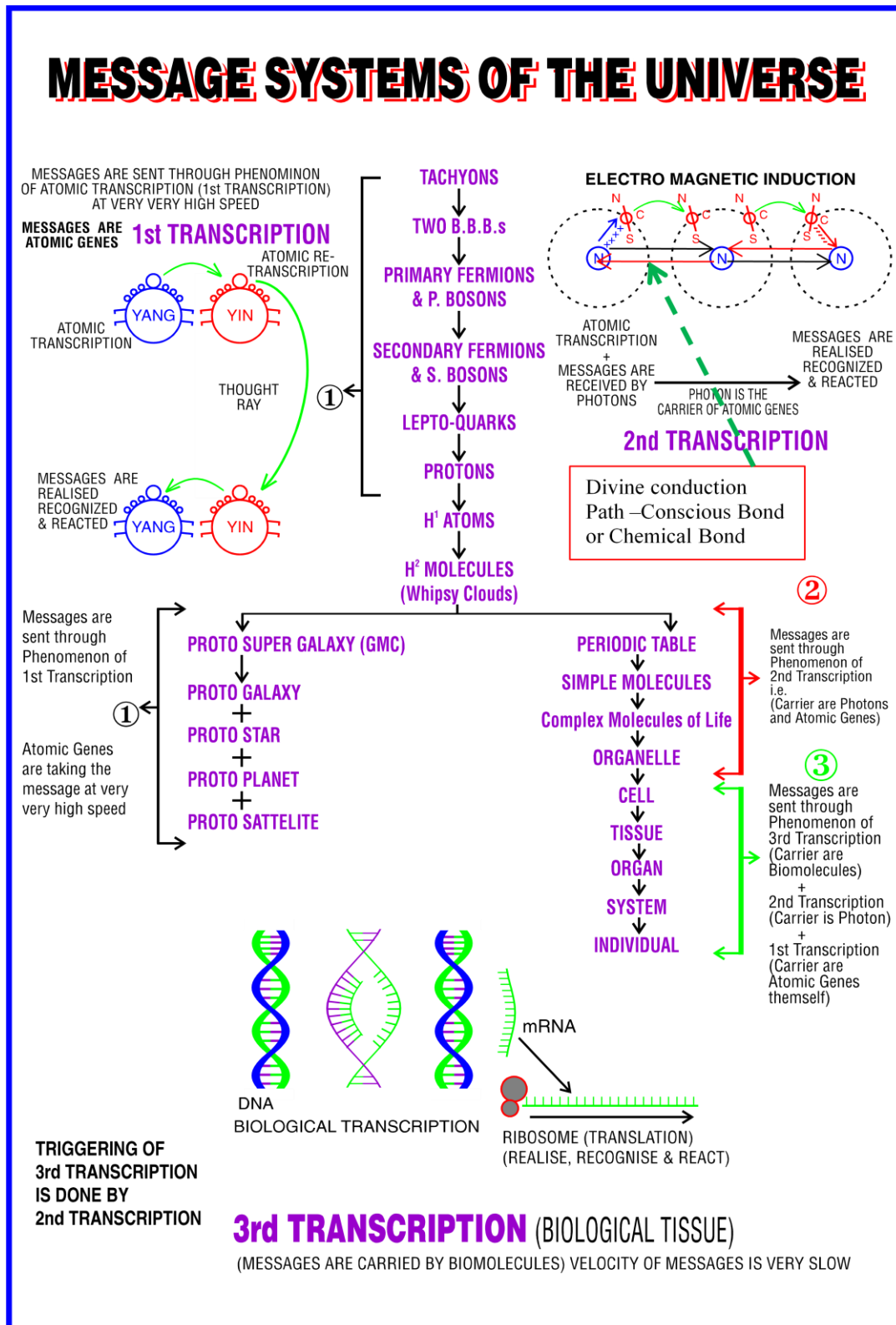

Fig. 5 Messages system of the universe

1.6 How does nature work & triggering of normal & abnormal effects

To understand creation physics as shown in Fig 6 and Fig 7. . There are two types of thought stimulation [2] . One is **CONDITIONED THOUGHT STIMULATION** and other one is **UNCONDITIONED THOUGHT STIMULATION**.

STIMULATION OF THOUGHT EXPRESSION --- There are two types of thought expressions one is **CONDITIONED STIMULATION** of thought expression, and other one is **self stimulation of thoughts** i.e. **UNCONDITIONED STIMULATION** of thought expression .

At the time of the origin of the universe, all effects got created. The cause of all effects of the universe is **THOUGHT** expression. These thought expressions were triggered by **UNCONDITIONED OR SELF STIMULATED WAY** . It is the first step and it is followed by **PROGRAMMING** or formation of programmed messages by code **PCPs**. This programmed message moves from higher centers to target **B.B.Bs**. it is called **INTERACTION**. Having received the messages, the mind and mass of the target **B.B.Bs**. work in a synchronized way so as to produced the effects as thought by a the higher center. If the thought expression by higher center is normal, the shapes, properties and laws produced by target **B.B.Bs**. would be normal and if the thought expressions are abnormal, the shapes, properties and laws would be abnormal. This is the basic concept of transmutation phenomenon. Finally what we observe is called **EFFECT**.

Appearance of new shapes. properties and laws is called **TRANSMUTATION**. The first three steps are collectively called **CCP**. During transmutation process if **CCP** is written, it does mean that unless the thought, programming and interaction take place, nature cannot transmutate. Transmutation phenomenon is seen in particles, atoms, molecules and even in cells. The basic steps of any transmutation remain the same except that the thought expressions differ.

The subatomic particle are made up of more fundamental particles called Basic Building Blocks (B.B.Bs) which are made up of mind and mass. These B.B.Bs are divine in nature with the result they talk with each other by phenomenon called atomic transcription and translation (thought expressions). The triggering of broken symmetry is caused by atomic transcriptions. Unless the atomic transcriptions occur, subatomic particles could never exhibit phenomenon of broken symmetry. So the broken symmetry is never spontaneous. It is being mis understood that sub atomic particles do have spontaneous activities as far as broken symmetry is concerned. Hence the Nobel prize physics 2008 awarded to this work is too early to give prize.

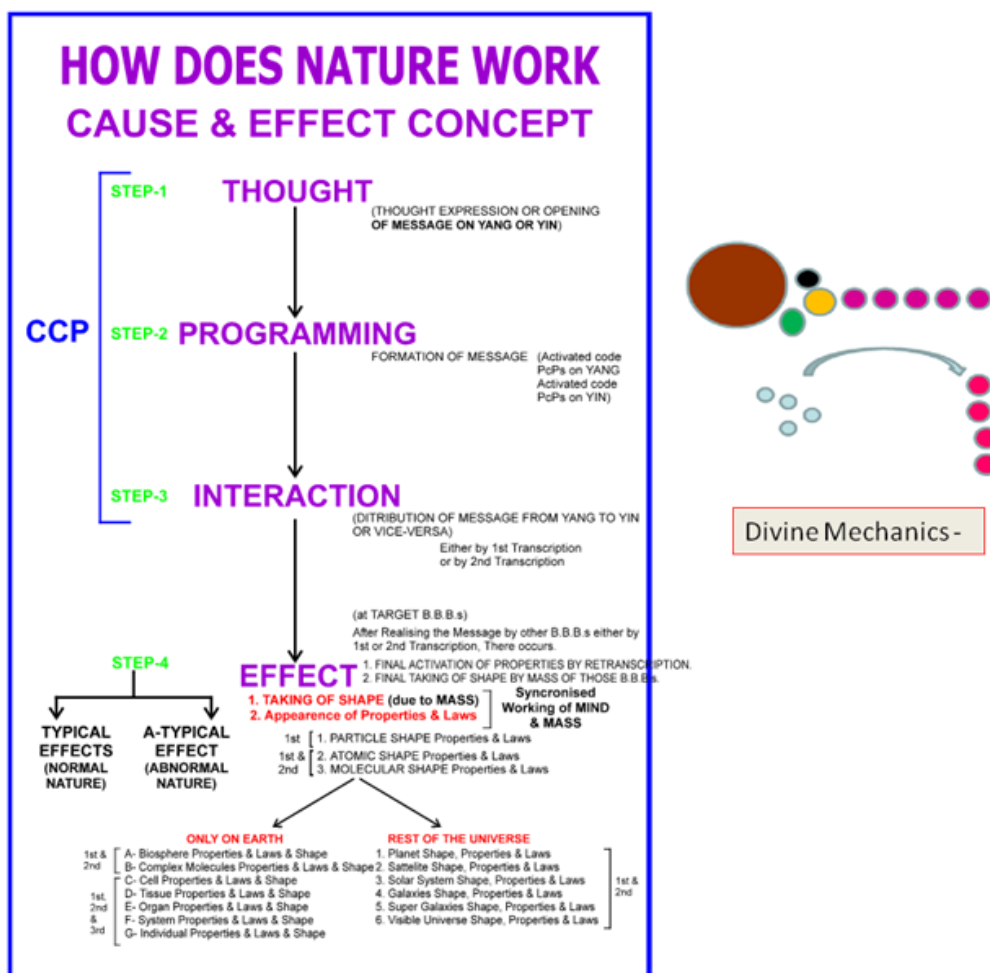

Fig. 6 Divine Mechanics – How Does Nature work ?

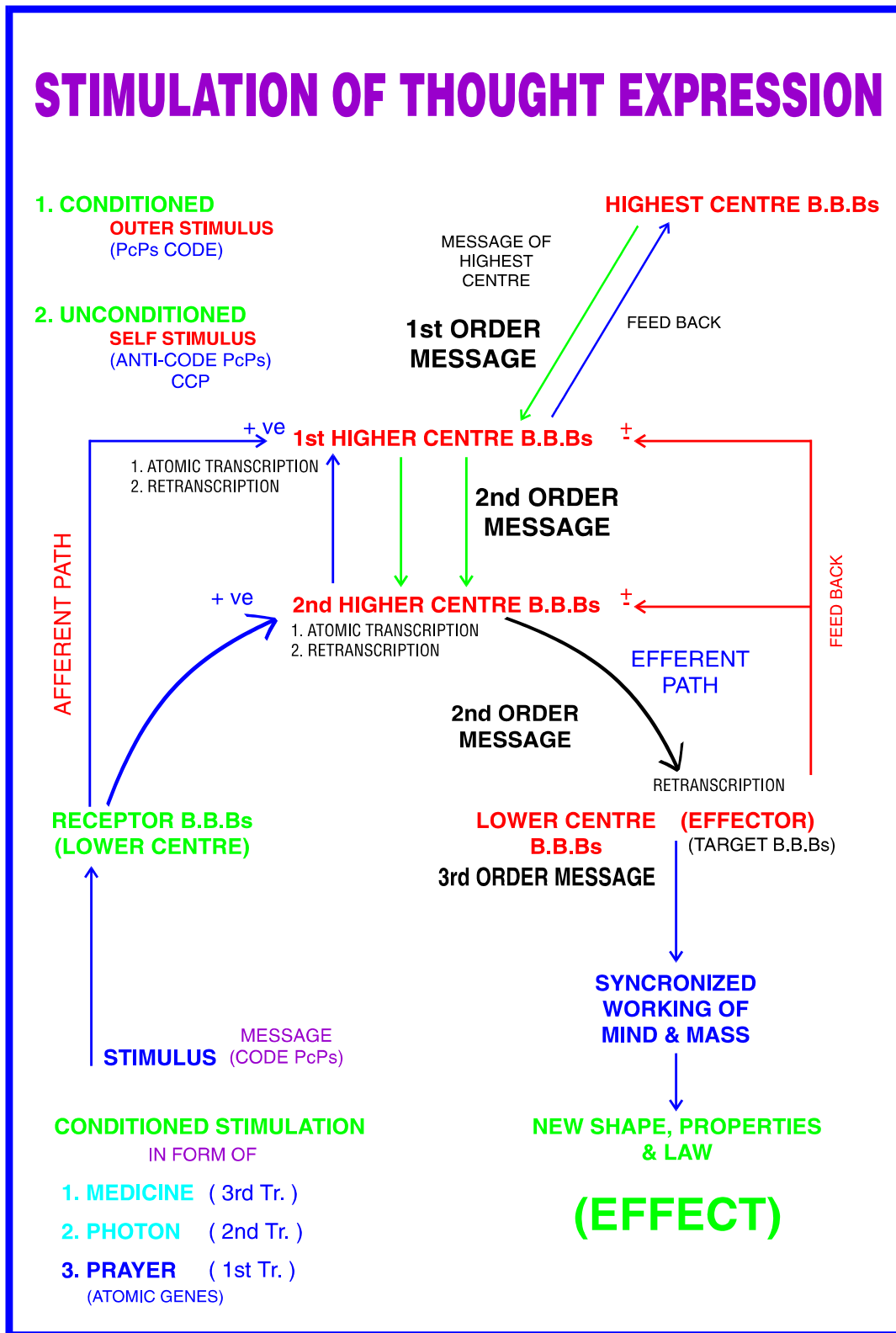

Fig. 7 Conditioned and Unconditioned thought expressions

1.7 Message network of the Universe (Feed Back Mechanism and different centers of the Universe)

With the origin of universe, nature first created primary units i.e. primary fermions (gravitation) and primary boson, these primary units are equipped with one higher center (one B.B.B.) and rest of the B.B.Bs. are working as lower centers or target B.B.Bs.[2] After primary units ,nature created secondary units i.e. secondary fermions and secondary bosons. similarly nature created tertiary units (lepto-quarks) and then quaternary units (protons& neutrons).

Each unit is equipped with higher centers, lower centers and target B.B.Bs. After quaternary units nature created atomic units, molecular units, complex molecules of life units, organelle units, cell units, tissue units, organ units, system units and individual units. Each unit is equipped with higher centers, lower centers, and target B.B.Bs. Similarly nature created satellite units, planet units, solar system units, galaxy units, super galaxy units, dark matter layer unit. These units are also equipped with higher centers, lower centers and target B.B.Bs. Thus our universe is divided into different units and each unit is equipped with higher and lower centers. All higher centers are under control of highest center of the universe by efferent paths. This efferent path is made up of first transcription. Higher centers can send messages to highest center of the universe by afferent path or feedback path. Thus highest center of the universe is well informed about all effects of the universe. Messages can come from lower centers to higher centers and from higher centers to highest center of the universe via afferent path. The highest center of the universe can send messages to higher centers and from higher center to lower centers. There is an inter unit message network also which is made up of first, second and third transcription depending upon the nature's need. Thus the entire universe is under control of highest center of the universe. Highest center can change any programming programmed by it during pre creation era as shown in Fig 8

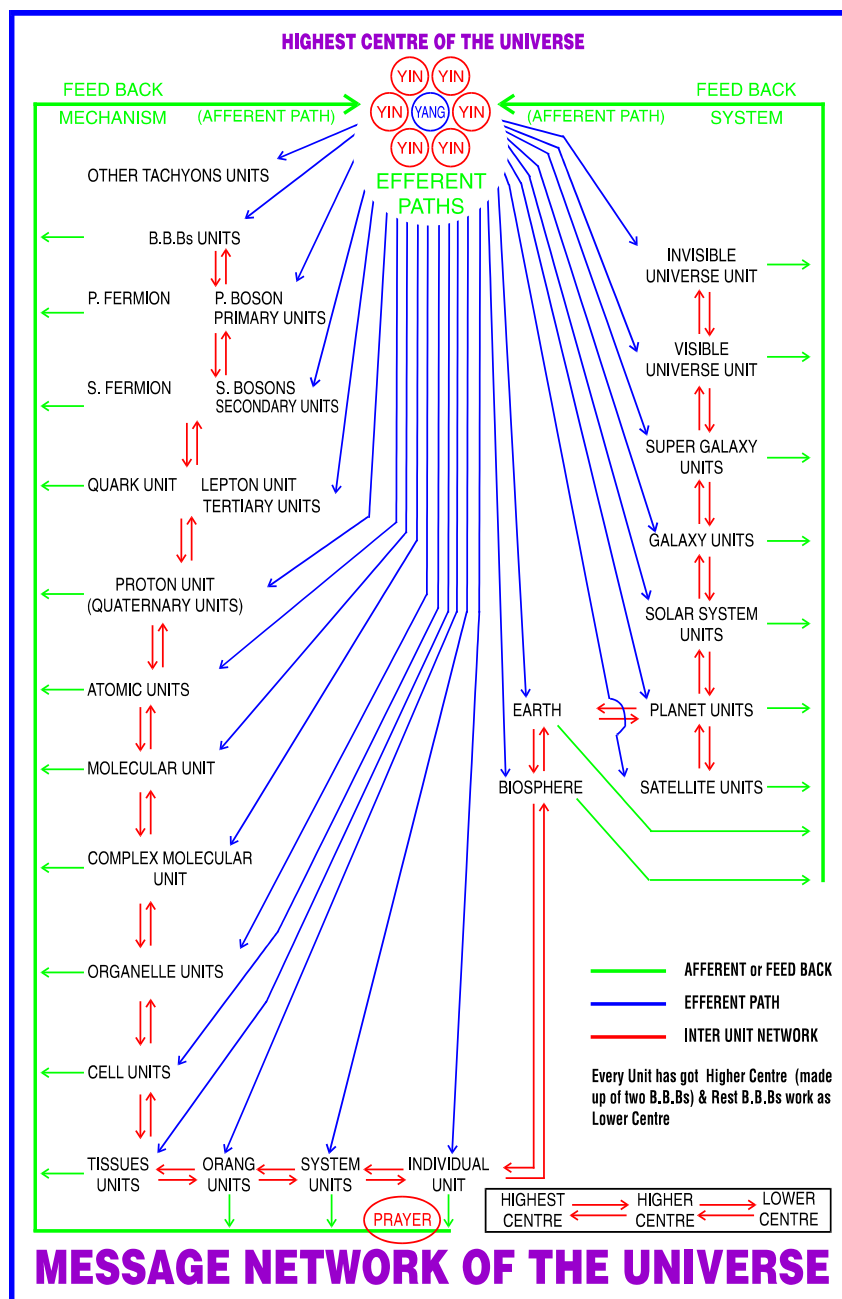

Fig. 8 Messages Net work of the Universe

1.8 Origin of the universe [7]

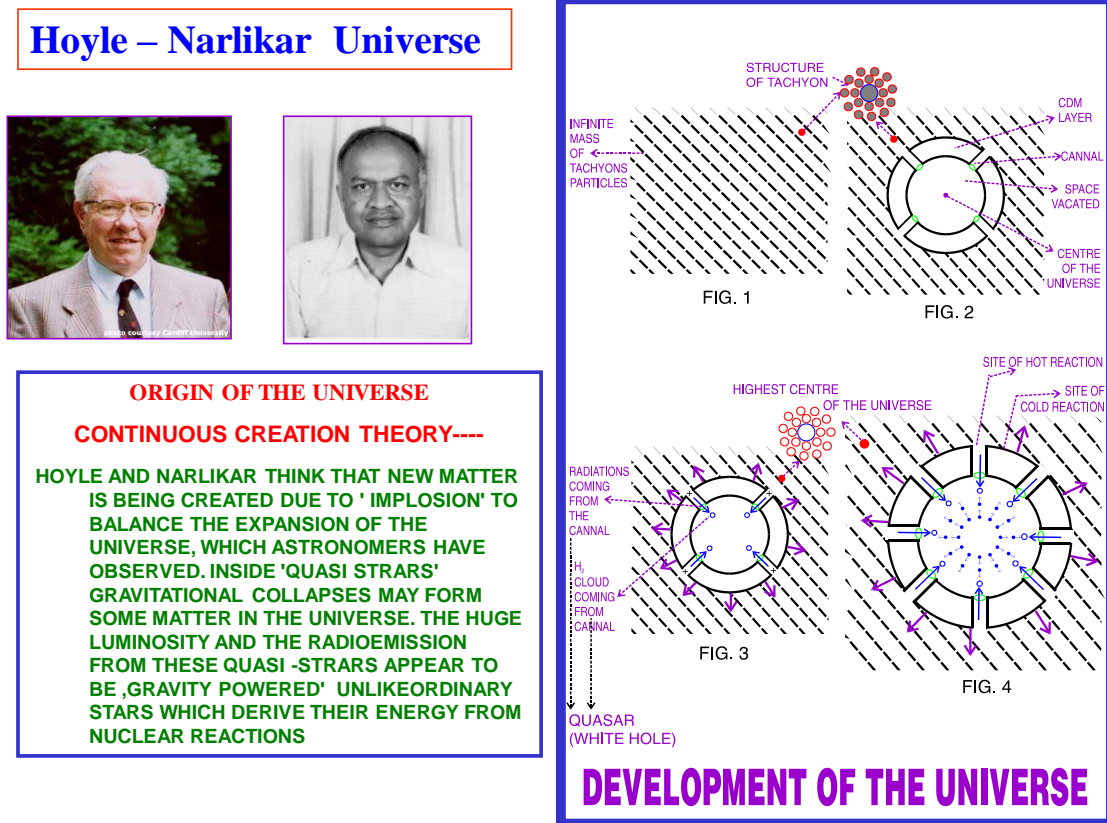

Fig. 9 Development of the Universe

Before the origin of the universe, these Basic Building Blocks (B.B.Bs) as shown in **Fig-3** were in the form of tachyons as shown in **Fig- 9** [7]. It means that at that time the tachyons were everywhere in the universe. Let us look at the structure of tachyons; it is made up of one matter B.B.B. (YANG) and many energy (YINs) B.B.Bs. Initially out of the infinite tachyons, one became the **highest center** of the universe. Messages used to go from highest center to rest of the universe and messages could come from rest of the universe to highest center of the universe by atomic transcription. Thus highest center had fed its thought to rest of the B.B.Bs. that would take part in creation - that they would express only those thoughts to give desired effect as wished by the highest center of the universe. So all B.B.Bs were informed about their role before creation of the universe. In pre-creation era programming of the future universe was done by highest center of the universe. Our universe is oscillating and it is a divine universe. It means that it has a creation phase and a destruction phase. During creation phase tachyons break into their B.B.Bs. and from these B.B.Bs, formation of fermions and bosons take place as shown in **Fig 3.1**. After the creation phase, destruction would start and in this phase all created particles would again break into their B.B.Bs and finally tachyons would form. At the time of origin of the universe, all the effects got created. These effects are taking of different shapes and appearance of properties and laws. All these effects are studied in various branches of science.

With the origin of the universe, nature first created a sphere of **COLD DARK MATTER (C.D.M)** and canals in it. With the result space got created. At the other end of the canals, hot reaction started (**the relics are back ground radiations 2.7 degree K of our hydrogen clouds**). As a result hydrogen clouds and lot of radiations were created. The empty canals were filled by these hydrogen clouds and radiations and thus **QUASARS** appeared in the universe. Simultaneously C.D.M. layer started expanding and clouds and radiations kept on coming in this closed universe as shown in **Fig 9** . With the passage of time more and more C.D.M. layer formed, more and more quasars formed. The hydrogen cloud came in this closed universe. They started running towards C.D.M. layer as they were attracted by the gravity of C.D.M. layer. Those clouds, which were nearer, moved faster than those, which were away from CDM Layer. The **HUBBLE LAW**, can thus be explained. With some more passage of time, clouds were joined to form **GMC** (giant molecular clouds). Later by self-gravitation different proto stars, proto planets, proto satellites were formed. Finally stars became bright and thus bright galaxies appeared in this universe. Our universe is still in expansion phase and creation is still going inside quasars. It is to be remembered that highest center of the universe does not come in the visible

universe. It keeps on receiving the messages by atomic transcription and it has power to change any programming programmed by it during pre-creation era.

It is the atomic genes which constitutes mind part of reality. Mind incorporation in physics is awaited as theory of everything is not yet investigated . I have investigated theory of everything (ToE) and I found that while studying unified theory at the time of origin of the universe by Hoyle Narlikar universe , it was mind reality that triggered symmetry breaking phase . It is mind reality that triggers oscillation phenomenon of the universe. It is the mind reality which is behind perfect cosmological principle . There is nothing like artificial intelligence in the universe . These mind particles constitute intelligence of the universe that controls the deterministic order of the universe. It is the mind reality behind all effects of the universe. But this is not our mind rather it is mind of Almighty B.B.B (Yang B.B.B or matter B.B.B. or Male B.B.B working as Highest center of the universe) . His mind could be manipulated by prayer only . as shown in figure 9.1and 9.2

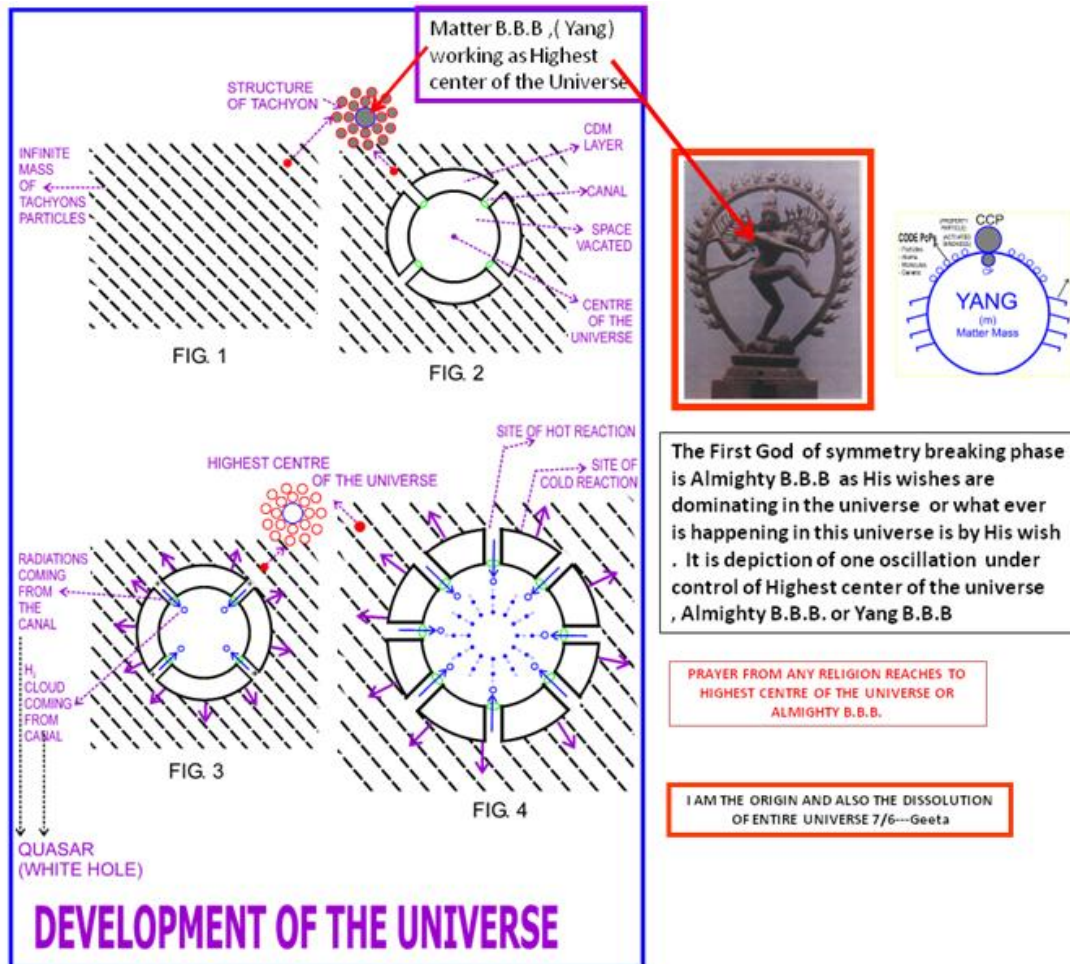

Figure 9.1 Hoyle Narlikar Universe

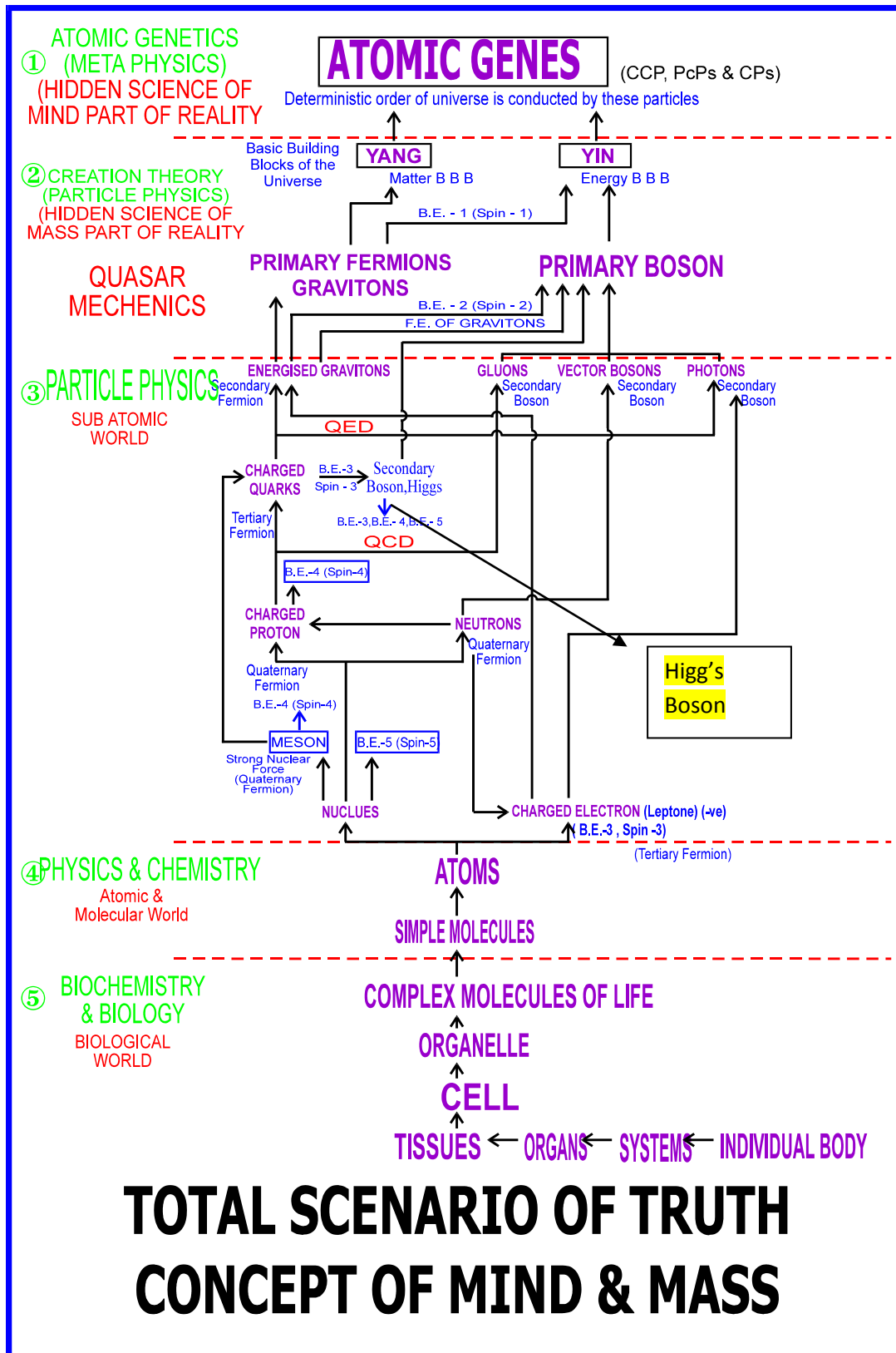

Fig 9.2 Total scenario of Truth Mind and Mass

1.9 DM and DE i.e. energized gravitons and energy pool of the universe as shown in Fig 10 and Fig 11 [8]

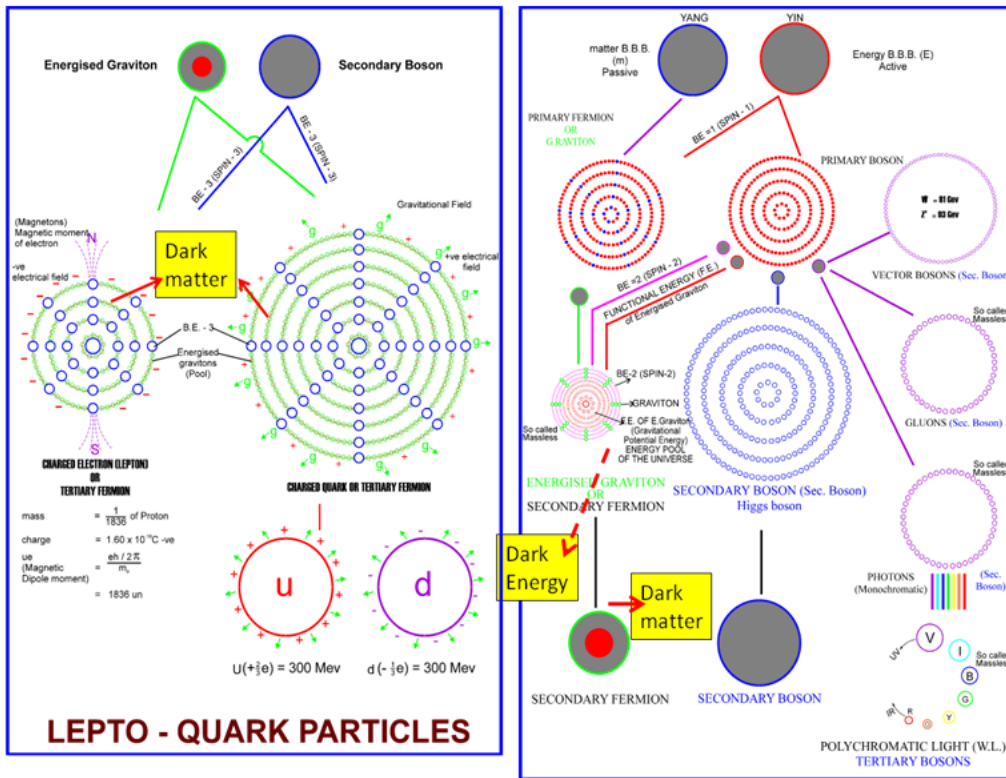

Fig. 10 Structural configuration of Leptons and Quarks as regard DM and structural configuration of DM and DE at micro level

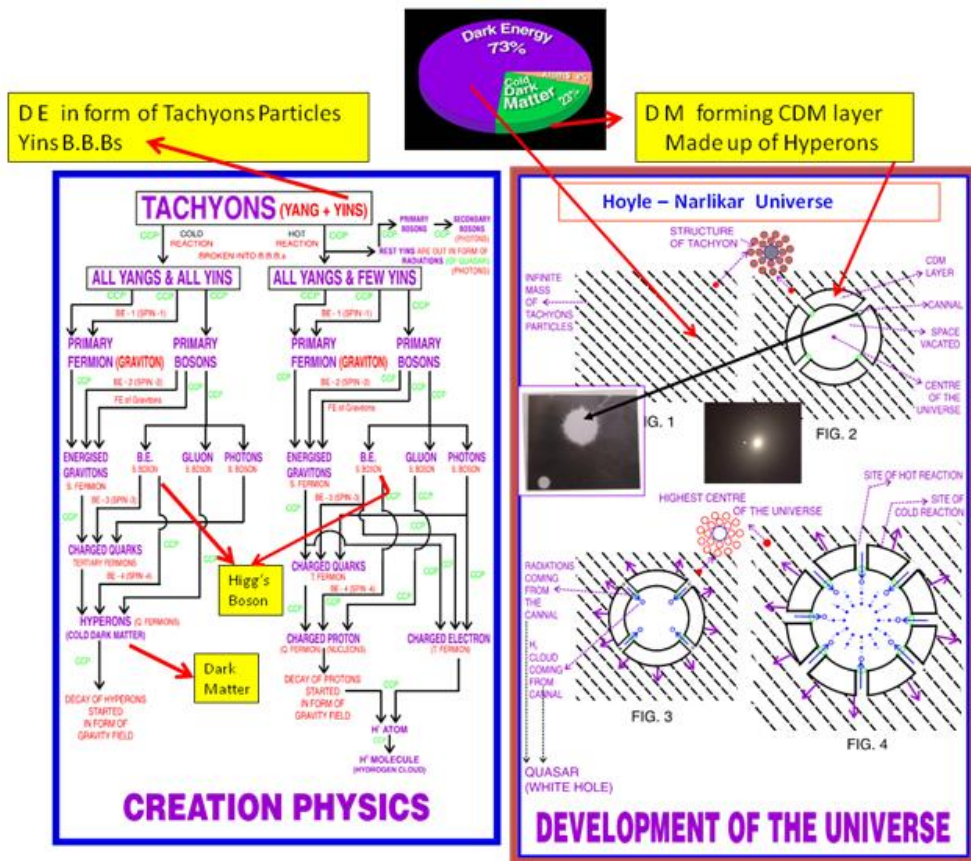
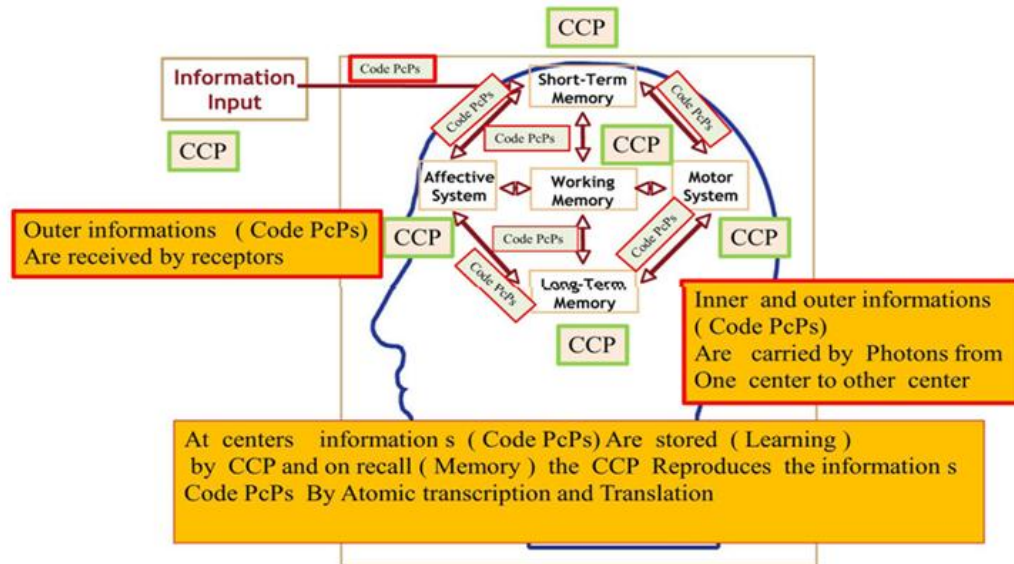

Fig 11 structural configuration of DM and DE at macro level [9]

1.10 Divine Mechanics and Brain Computation

Learning and Memory and information s (Code PcPs) Net work in Brain [10]



Divine Mechanics and Brain Computation

Fig 12 Divine Mechanics of Brain Computing System – Learning and memory

At all steps , these are B.B.Bs (B-Bit) that are responsible for information’s control and triggering . If CCP is written it means unless atomic transcription and translation occur , brain cannot have learning and memory triggering and control and it is called Divine mechanics of Biology and it is life . These are higher thought expressions of B.B.Bs . In Bits of classical computers and qubits of QC , the thought expressions are lower and different but the mechanics (DIVINE) remains the same. as shown in Fig 12

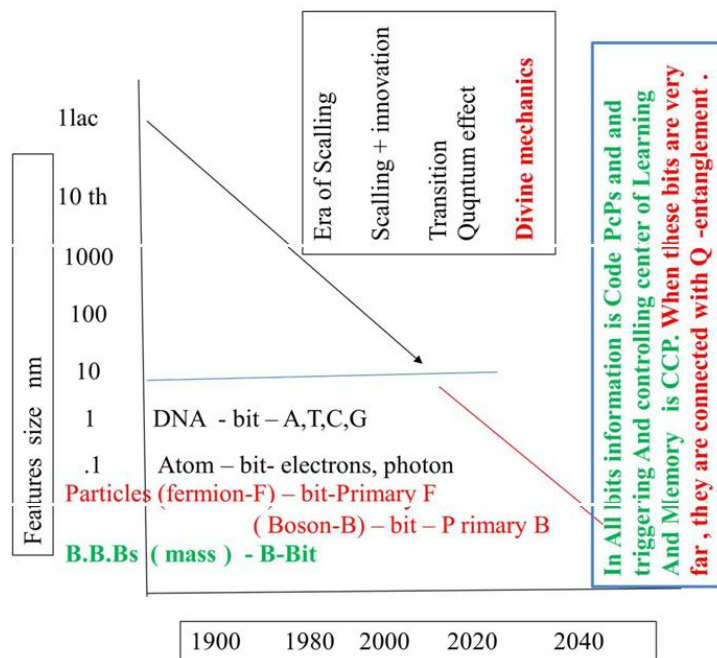

Physics dictates the lowest limit of size of chip **but DIVINE mechanics does not Moore’s Law Modified and Completed**

Fig 13- The Theory of Computers and Brain are same – DIVINE MECHANICS

(Structural and Functional smallest Bit (mass) is B-Bit of the universe and the Divine Mechanical Unit is CCP , Code PcPs and CP.)

DIVINE MECHANICS The Theory of Computers and Brain is SAME as shown in Fig 13

Physics dictates the lowest limits of the size of chips [11]. But divine mechanics does not . Hence the bit is a typical unit of information. ((Classical and Quantum Bit) is wrong and to describe informations by adding qubit is also illusion as in complicate system ,it is the different thoughts expressions that describe informations . Informations are separate (Code PcPs) and bits (Electron of transistor) qubits (electron of diamond crystal) are separate. At DNA level the bit is nucleotide (A,T,C,G) and at Atomic level the bit is photon and electron , at particle level (secondary fermions and secondary bosons) the bit is primary fermions and primary bosons and informations are still code PcPs and at B.B.B level the bit is B.B.B (Yang mass and Yin mass - B- bit) it self and the information is carried by Code PcPs but at all level of all bit units the information storage system is CCP (Physiological arrow of Time) it never dies even after destruction of the universe. Hence information s are eternal . In computers, Bit is a structural configuration that describes information s of the system and information s are in form of Code PcPs. The working of the bit is triggered and controlled by thoughts of higher centers that form that bit. If the bit is classical (transistors of chips) the effect is different . But if the bit is qubit with entanglement the working is triggered and controlled by thoughts of higher center that form that crystal . In both the effect of describing informations would be different. One is classical (thought expressions are fixed and limited)and other one is quantum (thought expressions are changing and more wide to describe the more wide complicated system to have fast results .) . In life sciences in Brain the bit is again Photon and the information s are Code PcPs and they are triggered and controlled by CCP of higher centers that is triggered by DIVINE MECHANICS .

In life sciences the CCP (cryptography) of B-bit expresses informations (Code PcPs) which were not fed like speaking Lie and unlike Bit of classical computer and qubit of QC it shows phenomenon of forgetfulness and IQ phenomenon (mental age /real age) . It is Higher functions of B.B.B or B Bit and it is life . Hence there is difference in some aspect of DIVINE MECHANICS \of Computers computation and Brain computation

II. Structure

2.1 Modified theory of atomic structure as Niels Bohr's theory has limitations in explaining different series of hydrogen spectra.

New assumptions of structure of hydrogen atom. – Divine Modified Niels Bohr 's Theory (**Divine MONB**)

1. Hydrogen atom is like a miniature solar system with the negatively charged electron moving in circular orbit around positively charged nucleus having positively charged particle proton. In this circular orbit or stationary orbits , electron is being held by single string of energized gravitons . This energy level is called ground state.
2. When Hydrogen atom is excited, the electron moves from ground state to excited state energy levels making a bigger circular orbit and having reached in this new energy levels , it also emits radiations . Hence absorption and emission of energy quanta occur simultaneously. Shifting is understood in inter orbital shift phenomenon.
3. When excitation is over, the electron once again come back to ground state energy level . All above mentioned events are triggered by different thoughts or atomic transcriptions from the nucleus or proton in case of hydrogen atom.
4. These atomic transcriptions are being triggered by conditioned stimulation of CCP by the message system made up of photons (second transcription or –ve charged photons or afferent path) coming from electron to proton and further they are transmitted by photons (second transcription made up of +ve charged photons, or efferent path) to electron. Having received the messages , electron works accordingly. Unless the thought is expressed, nature cannot work . as shown in Fig 7
5. When electron is in ground state, its interaction with energized graviton and electromagnetic photon is more hence IP -13.59ev (n=1) is required to remove electron from this energy level. During excited stage the interaction is different hence I.P. to remove electron from this state is -3.4ev (n=2), -1.511ev (n=3), -0.850ev (n=4) , -0.544ev (n=5) respectively. It is the changing thought of interaction with energized graviton and electromagnetic photons that gives changing effect .
6. Electronic configuration of higher atoms could be known by studying I.P. curve . Working of hydrogen atom as shown in Fig 14 .

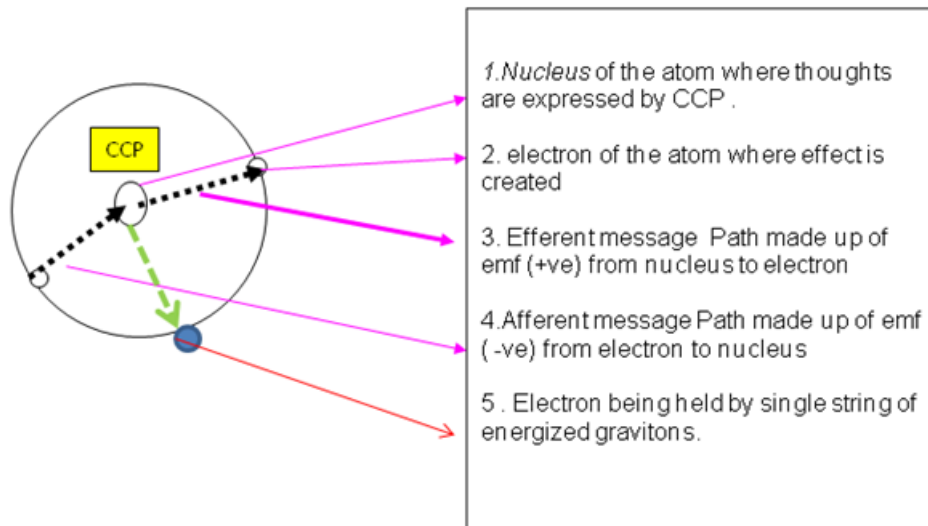

Fig 14 working of hydrogen atom – Divine MONB Theory

2.2 How cell works ?

The diagrams are self explanatory.

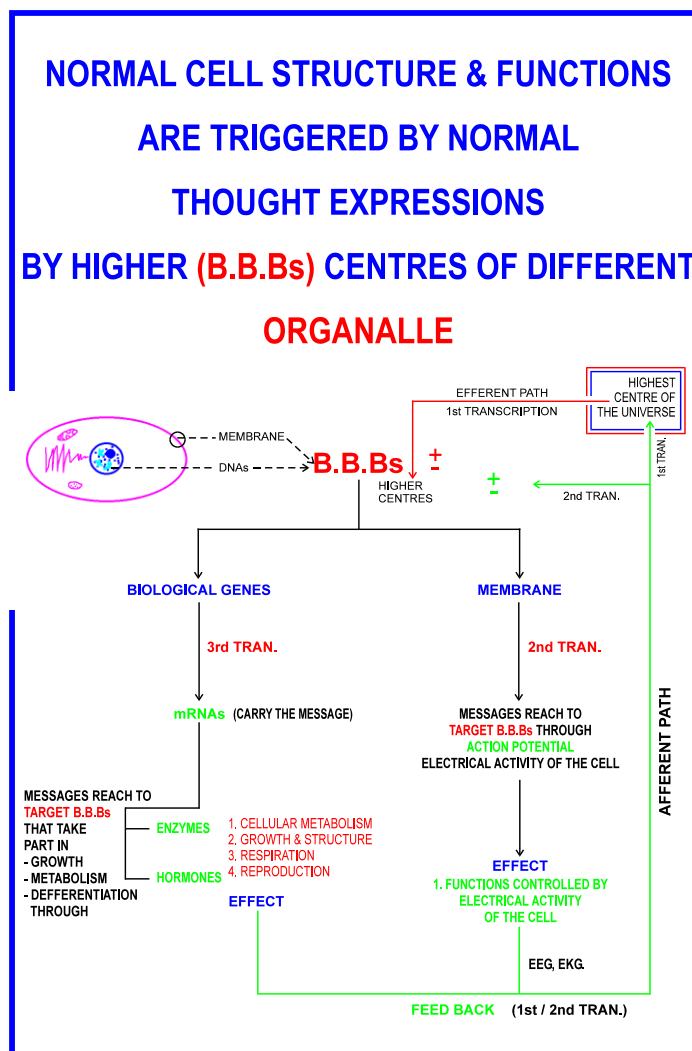

Fig 15 How cell works ?

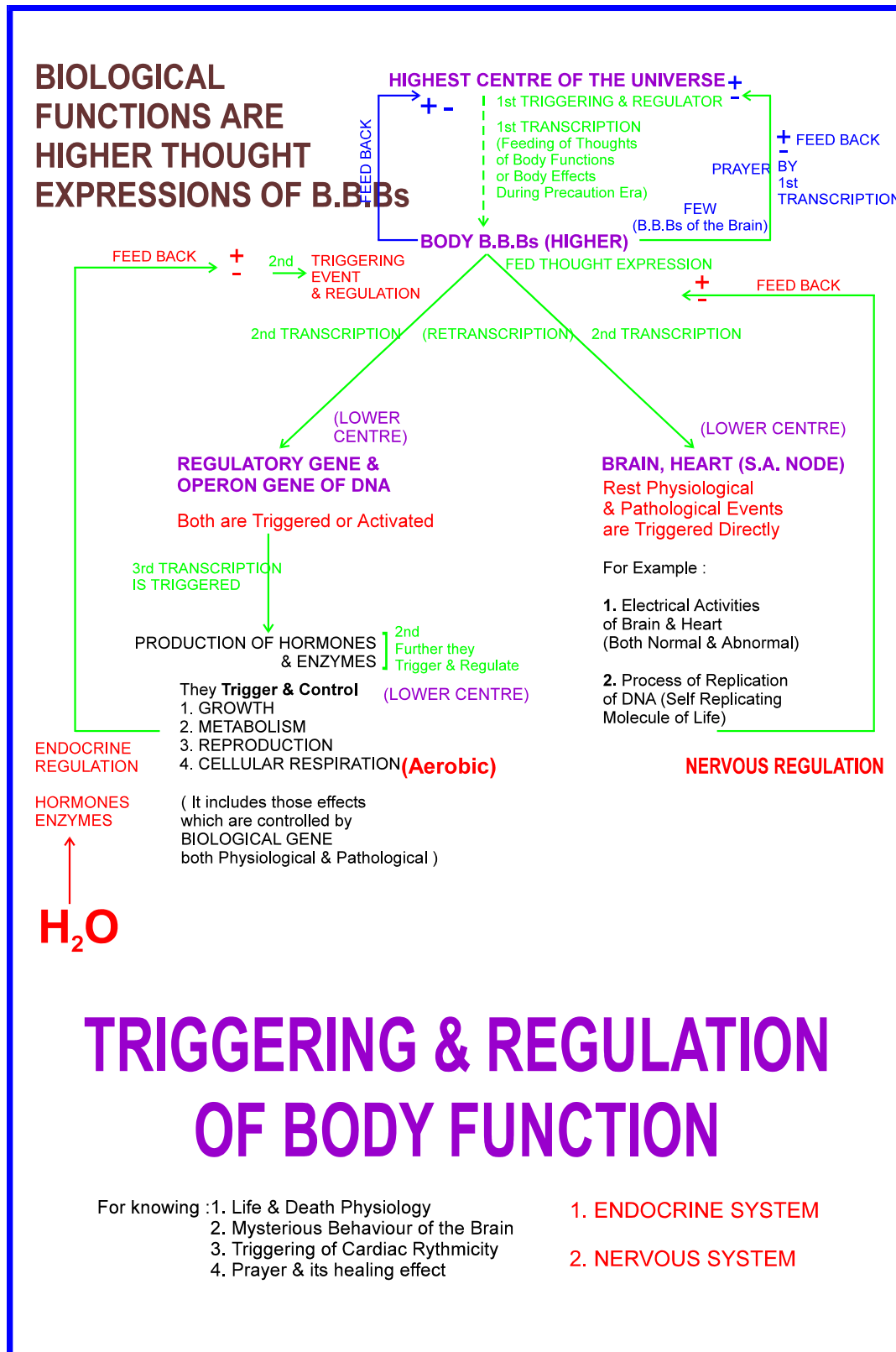

Fig 16 How cell works ?

2.3 Mechanism of Autophagy (micro level) Atomic transcription of formation of Autophagosome as shown in Fig 17

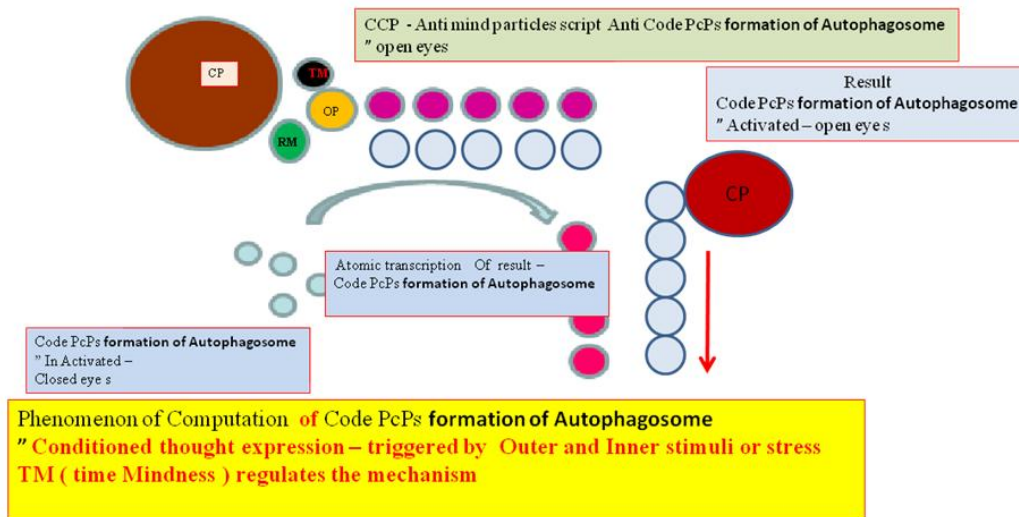

Fig 17 – Atomic transcription and translation of formation of Autophagosome (on Yang B.B.B)

In atomic transcription and translation of formation of Autophagosome , following steps take place on Yang B.B.B – B-Bit (higher center)

TM triggers the (unconditioned thought expression)

There is phenomenon of **Memory search** (of the result as it is there in memory after learning) by CP . Having searched the result , there is phenomenon of **memory expression** of the result by CP .

1. CP removes RM (repressor mindness-green) from OM (operating mindness -orange) thus induction of atomic transcription of result is triggered .
2. OM triggers activation of free mind particles (blue -inactivated code PCPs) of that thought script (magenta) of “Code PcPs formation of Autophagosome”.
3. Free mind particles (blue -inactivated Code PcPs formation of Autophagosome) get attached to anti mind particles script (magenta one) to form messenger thought script of “Code PcPs formation of Autophagosome”.
4. Messenger atomic genes (blue) get activated by anti mind particles thought script and further they get detached from anti mind particles thought script to form activated messenger atomic genes (activated code PCPs) (sky blue – open eye) of “Code PcPs formation of Autophagosome”
5. CP carries phenomenon of splicing by translating the messenger activated atomic genes (activated code PcPs) and finally there is activated message of “Code PcPs formation of Autophagosome” is formed .
6. CP represses atomic transcription by adding RM (green) to OM (orange) . Thus atomic transcription gets **halt**.

Divine MONB underpins formation of Autophagosome (micro level) as shown in Fig 18

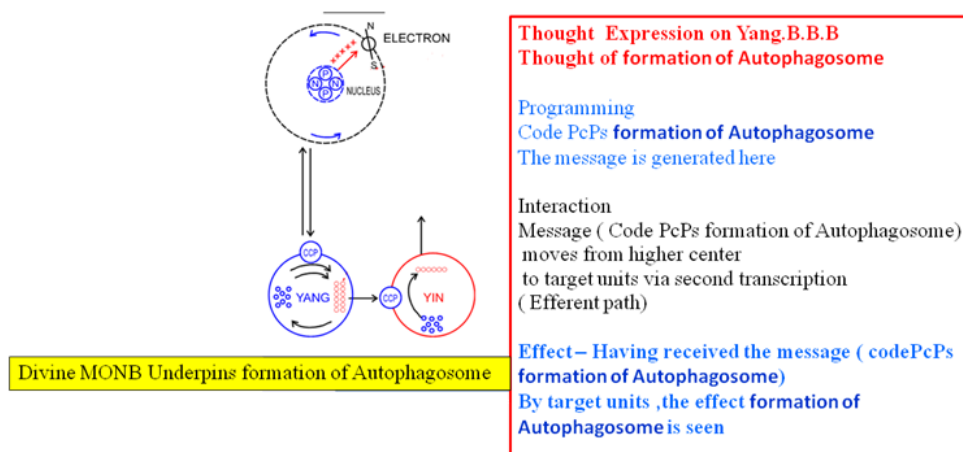

Fig 18 Divine MONB underpins formation of Autophagosome (micro level)

Divine MONB underpins formation of Autophagosome (Macro level) Triggering and Regulation of Formation of Autophagosome as shown in Fig 19

All molecules are Divine Units . There Working is triggered by Thought . Unless Thought is expressed molecules cannot enter in to Formation of Autophagosome. At each step of formation , if CCP is written , it means Divine Mechanics is first in action . Later programmed messages (Code PcPs) are formed . For formation , a specific messages (Code PcP) is expressed Step by step . It is T mindness that regulates the phenomenon. These specific Messages (Code PcPs) move from Higher Center to lower centers of target B.B.B s . The B.B.Bs of Different Molecules having received their specific messages (Code PcPs) , they translate it and they work accordingly .There is Feedback mechanism to higher centers every time Before next step is triggered . The phenomenon of autophagy is triggered by outer stimuli (outer stress or inner stress) . It is conditioned thought stimulation of CCP .

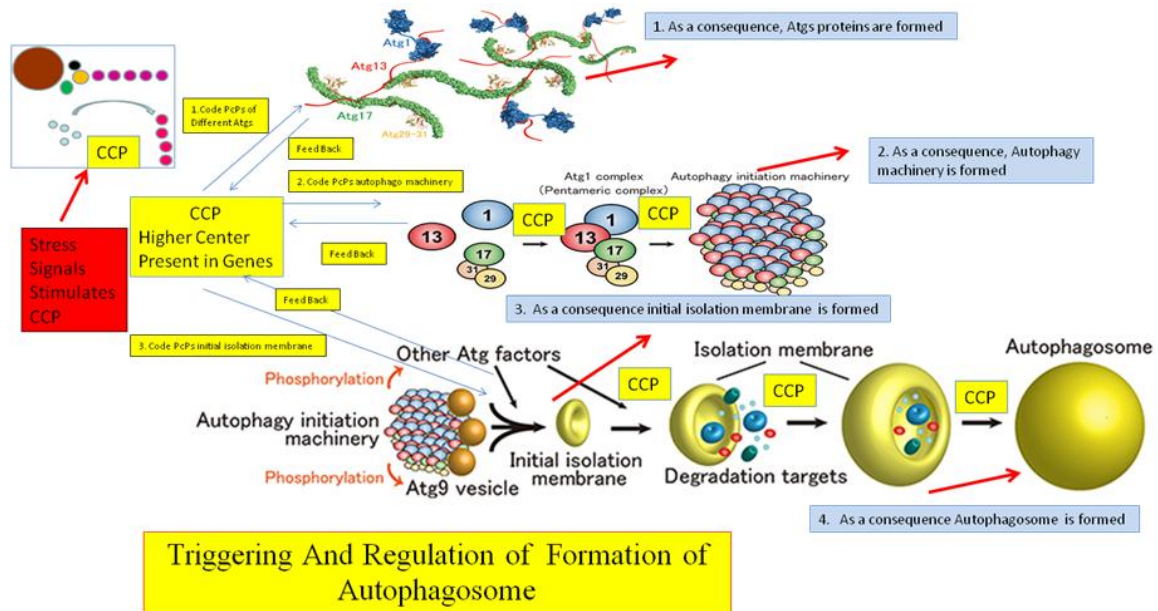

Fig 19 Divine MONB underpins formation of Autophagosome (macro level)

III. Conclusion

The normal cell structures and functions of normal cell are triggered by normal thought expressions of normal structural configuration and normal functions. That is why we observe normal structural configuration of cell and normal functions both originated by genes and membrane (electrical activity of the cell) . In autophagy , structural formation of autophagosome is triggered by basic building block (Yang B.B.B.) of genes involved in nucleus . Nucleus transcribes different mRNAs of structural proteins that are required in formation of autophagosome . These proteins are formed in cytoplasm and they unite to form autophagosome .

At each step , it is CCP that triggers and regulate the mechanism and there is feed back to higher center before next thought is expressed to complete the formation of autophagosome . There are many thoughts that are involved in the phenomenon of autophagy . But to understand the concept few thoughts are depicted in diagrams. The phenomenon of autophagy is triggered by outer stimuli (outer stress or inner stress) . It is conditioned thought stimulation of CCP . Hence the Nobel prize physiology 2016 has been given on anatomy (B-Bit) of phenomenon of autophagy rather than its physiology (divine mechanics) . In dead person physiology is absent . Physiology is higher thought expressions of B.B.B. in living body or living cell .

References

[1]. http://www.nobelprize.org/nobel_prizes/medicine/laureates/2016/press.html
 [2]. V M Das International journal of innovative research and development **Volume 3 Issue 8** p 194- 210 (2014)
 [3]. V M Das International Journal of Sciences: Basic and Applied Research (IJSBAR) **Volume 17, No 1**, p 292-324 (2014)
 [4]. V M Das International Journal of Sciences: Basic and Applied Research, **Volume 17, No 1**, p 148-185 (2014)
 [5]. V M Das International Journal of Sciences: Basic and Applied Research) **Volume 16, No 2**, p 274-309 (2014)
 [6]. W S Harris JAMA Arch Intern Med. **Volume 159, N019** , Oct-25 p 2273-2278 (1999)
 [7]. V M Das International Journal of Sciences: Basic and Applied Research **volume 16 , number 1** , p 311-338 (2014)
 [8]. V M Das Social and basic sciences and research review **Volume 2**, Issue 4 p 197-255 (2014)
 [9]. V.M.Das Asian Journal of Science and Technology **Vol.06 Issue 12**, pp.2075-2099 (2015)
 [10]. V.M.Das INTERNATIONAL JOURNAL OF SCIENTIFIC RESEARCH **Volume 4 Issue 5** pp 795-804 (2015)
 [11]. <https://www.youtube.com/watch?v=Fb3gn5GsvRk>